

## ELTLC DATASHEET

EasiLinc transmission protection module

For transmission line protection, with or without reclosing

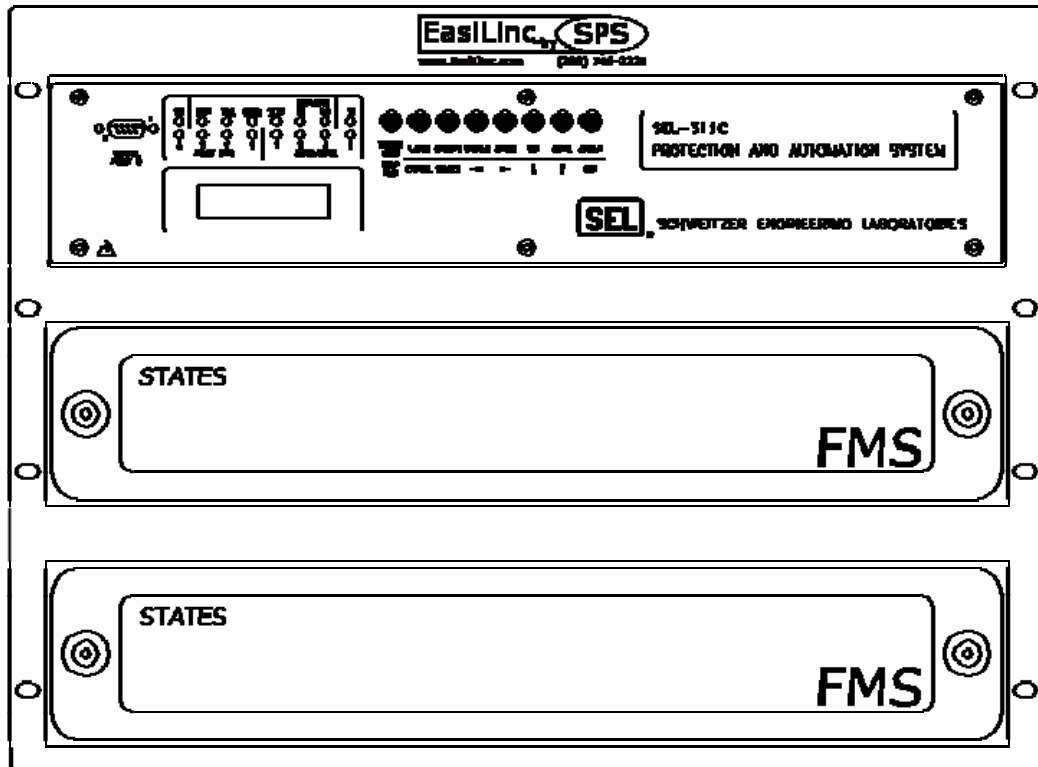

- Perfect for retrofit or new construction projects
- Minimal complexity, maximum performance
- No logic settings required
- Event recording, SER and battery monitoring functions active and configured
- Use in 19" equipment rack or panel cutout
- SEL-311C Relay and all test-switches mounted and wired
- For all transmission line applications

## The ELTLC protection module

The EasiLinc ELTLC protection module simplifies your use of microprocessor-based relays for transmission line protection. The module includes an SEL-311C Relay and appropriate test switches. These devices are pre-wired and installed in a mounting panel suitable for a 19" equipment rack or switchgear panel cutout. Also included are all the AC and DC application schematics you need to generate final construction prints quickly for your installation. The real time-saver is in the relay settings.

Set the ELTLC protection module using the proven EasiLinc Setting Transfer Software. EasiLinc STS contains a library of application setting files that configure most of the relay settings for each application. Application setting files enable and configure the best features of the SEL-311C Relay, leaving only the final protection settings for you.

Set the new relay using protection and reclosing concepts that you are familiar with, without learning any relay control commands or logic definition languages.

### The EasiLinc ELTLC Application Setting Files:

- Predefine output contact and control input functions.
- Enable event reporting, SER and battery monitoring functions.
- Prepare the relay for substation automation using EasiLinc ELCOM communication modules, ELHMI interface and ELPAGE paging modules.
- Support communication-assisted tripping schemes

### Using the ELTLC, you:

- Reduce engineering costs by reducing the relay setting count.
- Reduce electrical design costs by using the provided AC and DC schematics.
- Reduce installation and commissioning costs with pre-wired and pre-tested modules.
- Reduce substation automation costs by using the standard control interface.
- Standardize your design, installation, operation, and maintenance procedures.
- Obtain the accuracy, reliability and availability benefits of a high performance relay.
- Support accelerated deployment schedules by taking advantage of included design documents.

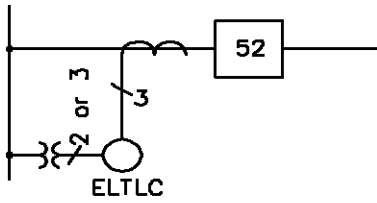

### Product applications

- Zone distance protection
- Ground overcurrent protection
- Communications assisted tripping

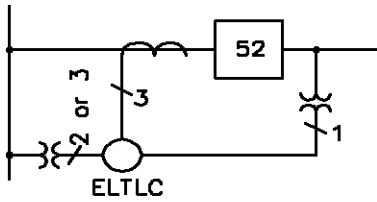

- Zone distance protection
- Communications assisted tripping
- Simple reclosing
- Sync check

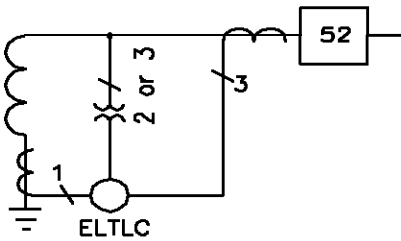

- Zone distance protection
- Communications-assisted tripping
- Auto-transformer neutral protection

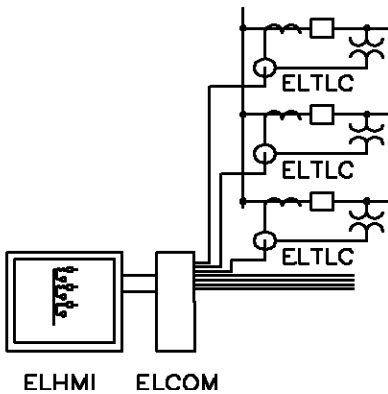

- Substation communication architecture using EasiLinc modules
- Architecture may be extended to central office locations
- Modular concept supports multi-stage projects
- Advanced notification solutions, including paging and e-mail are also available

## SEL- 311C Relay major features

- Phase fault distance protection, four zones mho, two zones are selectable forward or reverse
- Ground fault distance protection, four zones mho, four zones quadrilateral, two zones each are selectable forward or reverse
- CCVT transient detection prevents misoperations of zone 1 distance elements
- POTT and DCB communications-assisted tripping schemes
- Pilot channels include mirrored bits or input/outputs connected to external communications gear
- Phase, residual, negative sequence, and neutral instantaneous and time-overcurrent protection elements
- Reclosing with up to four shots
- Support for four-wire wye or three-wire open-delta voltage measurement
- Line-side voltage input for synch-check supervised and voltage-supervised reclosing
- Accurate metering functions for current, voltage, real and reactive power, frequency, DC battery voltage, demand, and energy
- Front-Panel LCD display indicates metered values and text messages of relay, breaker, and alarm conditions
- Event reporting that automatically captures and stores 22 most recent thirty-cycle oscillographic reports detailing current, voltage, contact I/O, and protection element conditions during events
- Sequence-of-events recording that captures, time-tags, and stores 512 latest state changes of contact inputs, contact outputs, control points, and protections elements
- Fault locating function that indicates the fault type, currents and fault location
- Broad operating temperature range:  $-40^{\circ}$  to  $+85^{\circ}\text{C}$  ( $-40^{\circ}$  to  $+185^{\circ}\text{F}$ )
- Type-certified to a wide range of electrical noise, temperature cycling and seismic

## Test switch major features

- Two 30-pole STATES FMS-type test switch banks are supplied with each ELTLC
- Each relay contact input and output is double-switched to provide complete isolation
- Four spare switch poles are available for owner use
- Switches are UL listed and CSA certified
- Clear covers allow pole markings to be viewed without removing covers
- Stud terminals and insulated ring-lugs provide secure internal connections

## EasiLinc Setting Transfer Software major features

- Tabular interface organizes settings into convenient categories
- Library of application setting files supports a wide variety of protection schemes. Additional files available for download when you log in at [www.EasiLinc.com](http://www.EasiLinc.com).
- Application Setting Files pre-define the vast majority of relay settings, including:
  - All logic settings
  - All event reporting, load profile and sequence-of-events record settings
  - All automation settings
- Print function documents all user settings on a single sheet
- Import/export functions simplify the deployment of settings to the field
- Setting transfer screen uploads relay settings with three mouse clicks
- Software automatically verifies an accurate settings transfer

The screenshot displays the EasiLinc Setting Transfer Software interface. The window title is "EasiLinc" and the menu bar includes "File", "Settings", and "Help". The main title is "EasiLinc Setting Transfer Software" with a dropdown menu showing "ELTLC App 1-Transmission Line Protection-060809". Below the title is a section "Select EasiLinc Model/Application to Configure". The interface is divided into tabs: "Setting Transfer", "Configuration", "Inst. Overcurrent", "Time-Overcurrent", "Phase Distance (21P)", and "GND Distance (21G)". The "Setting Transfer" tab is active, showing various settings in a grid format:

Relay ID	ELTLC	Terminal ID	ELTLC		
CT Ratio	240	:1	Polarizing CTR	240	:1
PT Ratio	2000.00	:1	Sync. PT Ratio	2000.00	:1
Phase Rotation	ABC				
Z1 Magnitude	1.00	ohms sec	Z1 Angle	75.00	deg
Z0 Magnitude	3.00	ohms sec	Z0 Angle	80.00	deg
Line Length	100.00				
Battery U/V Alm	100.00	Vdc	Battery Q/V Alm	150.00	Vdc

## Mechanical drawings

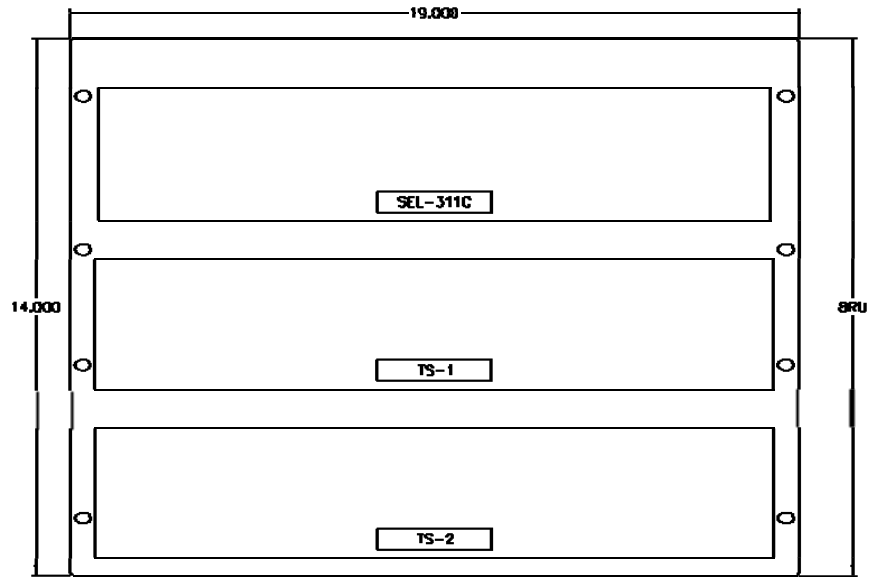

PANEL LAYOUT

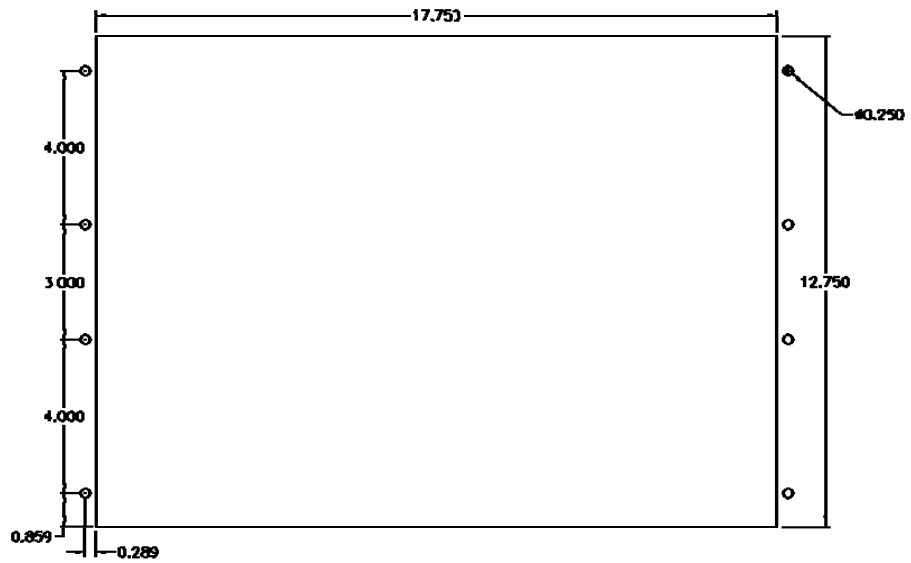

CUT & DRILL TEMPLATE

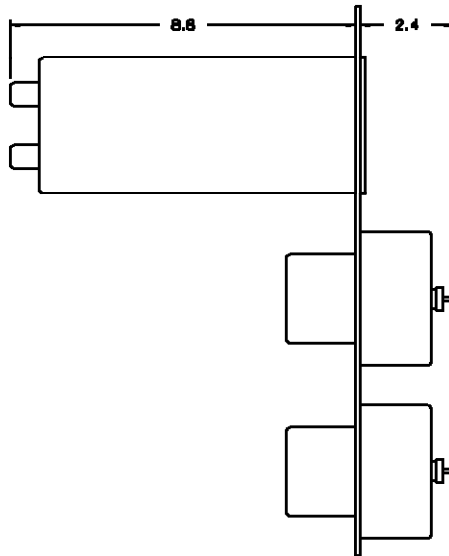

SIDE VIEW (STANDARD MOUNT)

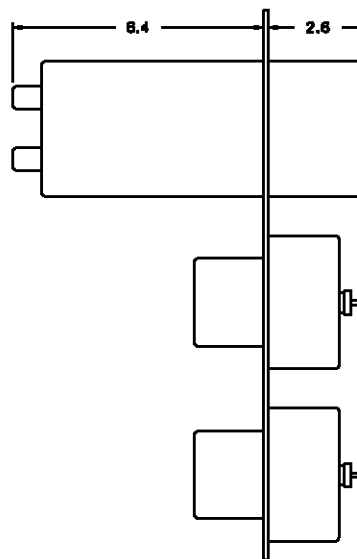

SIDE VIEW (PROJECTION MOUNT)

## Learn More

### HEADQUARTERS

POWER Engineers  
 3940 Glenbrook Drive  
 Hailey, Idaho 83333 USA  
 PHONE: 208-788-3456  
 FAX: 208-788-2082

### CLARKSTON, WASHINGTON

POWER Engineers  
 1300 16<sup>th</sup> Avenue, Suite 200  
 Clarkston, WA 99403 USA  
 PHONE: 509-758-6029  
 FAX: 509-758-6145

[www.easilinc.com](http://www.easilinc.com)

## Guideform specification

Vendor shall supply a microprocessor-based protective relay pre-wired with test switches in a mounting panel no larger than 8 rack units and suitable for mounting in a 19" equipment rack or in an appropriate panel cutout. The protection module shall be supported by AC three-line and DC schematic diagrams for the appropriate application options. Schematics shall be included in .pdf, .dwg, and .dxf electronic formats for finalization by the owner. The protection module shall be supported by a PC software package and a library of application setting files. Each application setting file shall pre-configure relay contact input and output logic functions, event report and SER generation, reclosing logic (if needed), and shall include logic and settings to support future operation with substation HMI and paging solutions. The software shall provide a simple interface for the user to configure the remaining protection and reclosing settings and download all settings to the protective relay. The software shall support the storage, printing, deployment and verification of the installation settings.

## ELTLC model numbers

ELTLC- \_ \_ \_ \_ - \_ \_ \_ \_ \_  
           a b c d e [Client Number]

Please contact your EasiLinc representative or POWER for your client number.

If your application requires:	Then Select:
Wye connected potential transformers: Delta connected potential transformers:	a = Y a = D
5 A secondary nominal current inputs: 1 A secondary nominal current inputs:	b = 5 b = 1
24Vdc/48Vdc Power Supply Rating: 48Vdc/125Vdc or 120Vac Power Supply Rating: 125Vdc/250Vdc or Vac Power Supply Rating:	c = 2 c = 3 c = 4
DC control input supply voltage:	d = 1 d = 2 d = 3 d = 4 d = 5 d = 6
Semi-flush mounting: Projection mounting:	e = S e = P

All brand or product names appearing in this document are the trademark or registered trademark of their respective holders.

Copyright POWER Engineers, Inc. 2009  
 (All Rights Reserved)